

TASCAM

TEAC Professional Division

DA-P1

Digital Audio Tape Recorder



OWNER'S MANUAL

D00174100B

Important Safety Precautions



CAUTION
RISK OF ELECTRIC SHOCK
DO NOT OPEN



CAUTION: TO REDUCE THE RISK OF ELECTRIC SHOCK, DO NOT REMOVE COVER (OR BACK). NO USER-SERVICEABLE PARTS INSIDE. REFER SERVICING TO QUALIFIED SERVICE PERSONNEL.



The lightning flash with arrowhead symbol, within equilateral triangle, is intended to alert the user to the presence of uninsulated "dangerous voltage" within the product's enclosure that may be of sufficient magnitude to constitute a risk of electric shock to person.



The exclamation point within an equilateral triangle is intended to alert the user to the presence of important operating and maintenance (servicing) instructions in the literature accompanying the appliance.

This appliance has a serial number located on the rear panel. Please record the model number and serial number and retain them for your records.

Model number _____
Serial number _____

WARNING: TO PREVENT FIRE OR SHOCK HAZARD, DO NOT EXPOSE THIS APPLIANCE TO RAIN OR MOISTURE.

IMPORTANT (for U.K. Customers)

DO NOT cut off the mains plug from this equipment. If the plug fitted is not suitable for the power points in your home or the cable is too short to reach a power point, then obtain an appropriate safety approved extension lead or consult your dealer.

If nonetheless the mains plug is cut off, remove the fuse and dispose of the plug immediately, to avoid a possible shock hazard by inadvertent connection to the mains supply.

If this product is not provided with a mains plug, or one has to be fitted, then follow the instructions given below:

IMPORTANT. DO NOT make any connection to the larger terminal which is marked with the letter E or by the safety earth symbol \equiv or coloured GREEN or GREEN-and-YELLOW.

The wires in the mains lead on this product are coloured in accordance with the following code:

BLUE: NEUTRAL
BROWN: LIVE

As these colours may not correspond with the coloured markings identifying the terminals in your plug proceed as follows:

The wire which is coloured BLUE must be connected to the terminal which is marked with the letter N or coloured BLACK.

The wire which is coloured BROWN must be connected to the terminal which is marked with the letter L or coloured RED.

When replacing the fuse only a correctly rated approved type should be used and be sure to re-fit the fuse cover.

IF IN DOUBT — CONSULT A COMPETENT ELECTRICIAN.

Safety Instructions

CAUTION:

- Read all of these Instructions.
- Save these Instructions for later use.
- Follow all Warnings and Instructions marked on the audio equipment.

- 1) **Read instructions** — All the safety and operating instructions should be read before the product is operated.
- 2) **Retain instructions** — The safety and operating instructions should be retained for future reference.
- 3) **Heed Warnings** — All warnings on the product and in the operating instructions should be adhered to.
- 4) **Follow instructions** — All operating and use instructions should be followed.
- 5) **Cleaning** — Unplug this product from the wall outlet before cleaning. Do not use liquid cleaners or aerosol cleaners. Use a damp cloth for cleaning.
- 6) **Attachments** — Do not use attachments not recommended by the product manufacturer as they may cause hazards.
- 7) **Water and Moisture** — Do not use this product near water – for example, near a bath tub, wash bowl, kitchen sink, or laundry tub; in a wet basement; or near a swimming pool; and the like.
- 8) **Accessories** — Do not place this product on an unstable cart, stand, tripod, bracket, or table. The product may fall, causing serious injury to a child or adult, and serious damage to the product. Use only with a cart, stand, tripod, bracket, or table recommended by the manufacturer, or sold with the product. Any mounting of the product should follow the manufacturer's instructions, and should use a mounting accessory recommended by the manufacturer.
- 9) A product and cart combination should be moved with care. Quick stops, excessive force, and uneven surfaces may cause the product and cart combination to overturn.



- 10) **Ventilation** — Slots and openings in the cabinet are provided for ventilation and to ensure reliable operation of the product and to protect it from overheating, and these openings must not be blocked or covered. The openings should never be blocked by placing the product on a bed, sofa, rug, or other similar surface. This product should not be placed in a built-in installation such as a bookcase or rack unless proper ventilation is provided or the manufacturer's instructions have been adhered to.
- 11) **Power Sources** — This product should be operated only from the type of power source indicated on the marking label. If you are not sure of the type of power supply to your home, consult your product dealer or local power company. For products intended to operate from battery power, or other sources, refer to the operating instructions.
- 12) **Grounding or Polarization** — This product may be equipped with a polarized alternating-current line plug (a plug having one blade wider than the other). This plug will fit into the power outlet only one way. This is a safety feature. If you are unable to insert the plug fully into the outlet, try reversing the plug. If the plug should still fail to fit, contact your electrician to replace your obsolete outlet. Do not defeat the safety purpose of the polarized plug.
- 13) **Power-Cord Protection** — Power-supply cords should be routed so that they are not likely to be walked on or pinched by items placed upon or against them, paying particular attention to cords at plugs, convenience receptacles, and the point where they exit from the product.
- 14) **Outdoor Antenna Grounding** — If an outside antenna or cable system is connected to the product, be sure the antenna or cable system is grounded so as to provide some protection against voltage surges and built-up static charges. Article 810 of the National Electrical Code, ANSI/NFPA 70, provides information with regard to proper grounding of the mast and supporting structure, grounding of the lead-in wire to an antenna discharge unit, size of grounding conductors, location of antenna-discharge unit, connection to grounding electrodes, and requirements for the grounding electrode.

"Note to CATV system installer:

This reminder is provided to call the CATV system installer's attention to Section 820-40 of the NEC which provides guidelines for proper grounding and, in particular, specifies that the cable ground shall be connected to the grounding system of the building, as close to the point of cable entry as practical.

Example of Antenna Grounding as per National Electrical Code, ANSI/NFPA 70

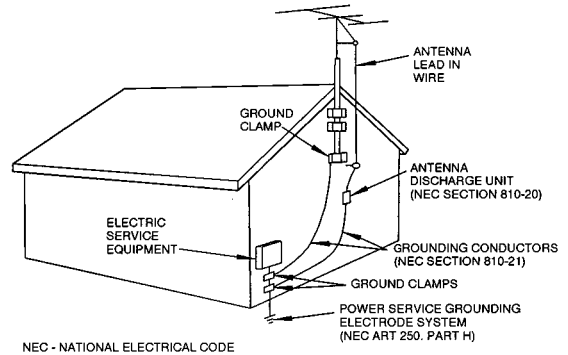

- 15) **Lightning** — For added protection for this product during a lightning storm, or when it is left unattended and unused for long periods of time, unplug it from the wall outlet and disconnect the antenna or cable system. This will prevent damage to the product due to lightning and power-line surges.
- 16) **Power Lines** — An outside antenna system should not be located in the vicinity of overhead power lines or other electric light or power circuits, or where it can fall into such power lines or circuits. When installing an outside antenna system, extreme care should be taken to keep from touching such power lines or circuits as contact with them might be fatal.
- 17) **Overloading** — Do not overload wall outlets, extension cords, or integral convenience receptacles as this can result in risk of fire or electric shock.
- 18) **Object and Liquid Entry** — Never push objects of any kind into this product through openings as they may touch dangerous voltage points or short-out parts that could result in a fire or electric shock. Never spill liquid of any kind on the product.
- 19) **Servicing** — Do not attempt to service this product yourself as opening or removing covers may expose you to dangerous voltage or other hazards. Refer all servicing to qualified service personnel.
- 20) **Damage Requiring Service** — Unplug this product from the wall outlet and refer servicing to qualified service personnel under the following conditions:
 - a) when the power-supply cord or plug is damaged.
 - b) if liquid has been spilled, or objects have fallen into the product.
 - c) if the product has been exposed to rain or water.
 - d) if the product does not operate normally by following the operating instructions. Adjust only those controls that are covered by the operating instructions and will often require extensive work by a qualified technician to restore the product to its normal operation.
 - e) if the product has been dropped or damaged in any way.
 - f) when the product exhibits a distinct change in performance – this indicates a need for service.
- 21) **Replacement Parts** — When replacement parts are required, be sure the service technician has used replacement parts specified by the manufacturer or have the same characteristics as the original part. Unauthorized substitutions may result in fire, electric shock, or other hazards.
- 22) **Safety Check** — Upon completion of any service or repairs to this product, ask the service technician to perform safety checks to determine that the product is in proper operating condition.
- 23) **Wall or Ceiling Mounting** — The product should be mounted to a wall or ceiling only as recommended by the manufacturer.
- 24) **Heat** — The product should be situated away from heat sources such as radiators, heat registers, stoves, or other products (including amplifiers) that produce heat.

Introduction

Your new TASCAM deck is a heavy-duty, portable R-DAT recorder/reproducer designed for outdoor recording needs in various fields from sound reinforcement through broadcast production. Facilities include operation using battery or AC current, backlit LCD display, protection against accidental operations, settings for two sampling rates when recording via the analog inputs, S/PDIF I/O port, ID editing modes, and others, as discussed later in this manual.

Table of Contents

Important Safety Precautions	2
Safety Instructions.....	3
Introduction	4
Precautions and Recommendations	4
Structure of DAT Cassettes	5
Subcodes	5
Using the Battery	6
Hookup.....	6
Recording.....	7
Playback.....	11
Editing Start and Skip ID Marks.....	12
Features and Controls.....	14
Specifications	20
Problems and Solutions.....	21
Block Diagram	22
Optional Accessories.....	23

Precautions and Recommendations

Environmental Conditions

This deck may be used in most areas, but to maintain top performance and prolong operating life, observe the following environmental limitations :

- 1) Nominal temperature should be 5 to 35 degrees Celsius (41 to 95 degrees Fahrenheit).
- 2) Relative humidity should be 30 to 90% (non-condensing).
- 3) Strong magnetic fields should not exist nearby.

Beware of Condensation

When the deck is moved from a cold to a warm place or used after a sudden temperature change, there is the danger of condensation ; water vapor in the air could condense on the internal mechanism, making proper operation impossible. To prevent this, or if this occurs (as confirmed by the  indicator blinking in the LCD display window), leave the deck for 1 or 2 hours with the power turned on, then turn the power off before turning it on again.

How to Load a DAT Cassette

The hinged edge of the cassette must go in first, clear window up. The cassette holder can open before power-up or while in STOP (the CHARGE/OPERATE switch must, however, be set to OPERATE).

 *When removing cassettes, don't pull on the cassette's slider to insure against possible damage to the naked tape.*

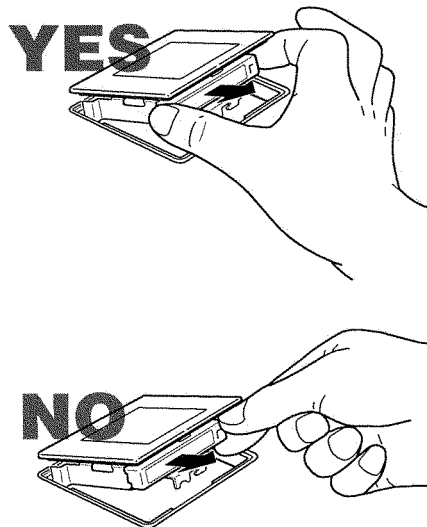

Structure of DAT Cassette

Bottom View

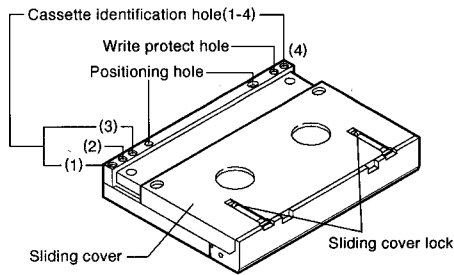

Identification Hole			Signified
1	2	3	
x	x	x	Metal coating or equivalent/ 13 µm tape thickness
x	o	x	Metal coating or equivalent/ Thin tape
x	x	o	1.5 time track pitch/ 13 µm tape thickness
x	o	o	1.5 time track pitch/ Thin tape
o	-	-	(Reserved for auxiliary tape type definitions)

Where: "o" = Open "x" = Closed

- Hole #4 shows "prerecorded" (Open) or not (Closed).

Top View

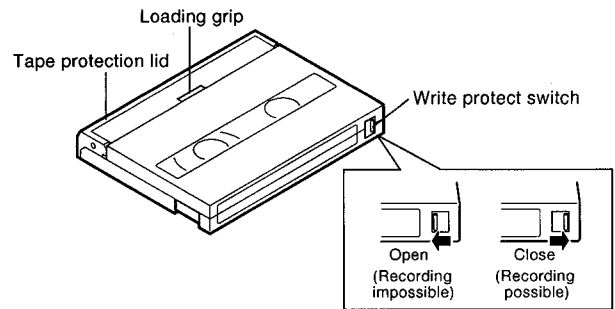

- Dimensions: 73 × 54 × 10.5 mm (W × D × H)
- Tape width: 3.81 mm

Notes:

- Cassette shells are designed to prevent touching the tape directly by hand.
- DAT cassettes record and play in one direction only. Do not load DAT cassettes upside down.
- DAT cassettes have a tape protection lid on the front edge to protect the tape. Do not open this lid forcibly, and do not pull the tape out from the cassette or touch it with your fingers.
- Be sure to replace DAT cassettes in their plastic case for storage.
- Do not place DAT cassettes on a television, speaker or near equipment which could generate a magnetic field.
- The tape used in 180-min cassettes is extremely thin and can cause winding problems, crimping, wrinkling, and other damage to the tape which will destroy your work. Don't use 180-min cassettes in this deck.

Subcodes

The following subcodes are available.

Subcode		Identifies:	Length and Location of Data Recording	Recorded Automatically or Manually
Index Data	Start ID	Beginning of each program	9 seconds at the beginning of each program	Auto and Manual
	Skip ID	Point from where tape is made to fast wind to the next Start ID	1 second at the desired point	Manual only
	End ID	End of the existing audio recordings	9 seconds at the end of the last recording	Manual only
	Program Number (PNO)	How many programs from the beginning of the tape is the current one	9 seconds at the beginning of each program	Auto only
Time Data	Absolute Time (ABS)	Elapsed time from the beginning of the tape	Full length of the audio recordings	Auto only
	Program Time	Elapsed time from the beginning of each program	9 seconds at the beginning of each program	Auto only

Note: If play starts from an intermediate point beyond the program-time recorded section, the display does not show the elapsed time from the beginning of the program.

Using the Battery

The supplied battery (and also the optional BP-D1 battery) has been charged to 60 % of its full power at factory. When the power drops to a point where the battery needs to be recharged, the battery warning indicator  flashes in the LCD display.

- A slide knob is attached on the side of the battery. This knob is used to show whether the battery is "exhausted" or "charged". Therefore, the knob does not have any direct effect on the battery performance.

CAUTION

Recharge the battery only when the battery warning FLASHES or its service life is shortened.

How to Load the Battery

Insert the battery, terminal side down, as illustrated.

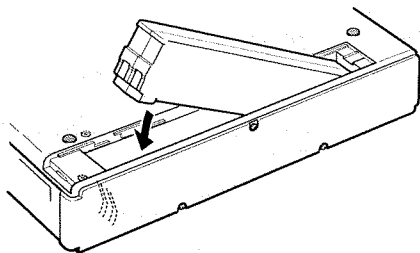

How to Recharge the Battery

Set the **CHARGE/OPERATE** switch to the CHARGE position to start charging the battery. A full charge is achieved in about 2.5 hours.

When the battery is being charged, an LED lights red on the PS-D1 adaptor/charger for the first 2 hours, then turns green to indicate that you can stop charging after about 30 minutes by removing the battery pack from the deck. Remember, the LED does not automatically turn off.

Insert the charged battery into the deck only when you operate the deck using the battery. Don't leave the battery inside the deck when operating under AC power for long periods.

Auto Power Off When Using the Battery

The Auto Power Off feature turns off the deck if you leave it in STOP for 6 minutes.

If you want to override this feature or prevent it from functioning, hold down STOP and slide POWER to the right.

Hookup

WARNING

Make all connections with power off.

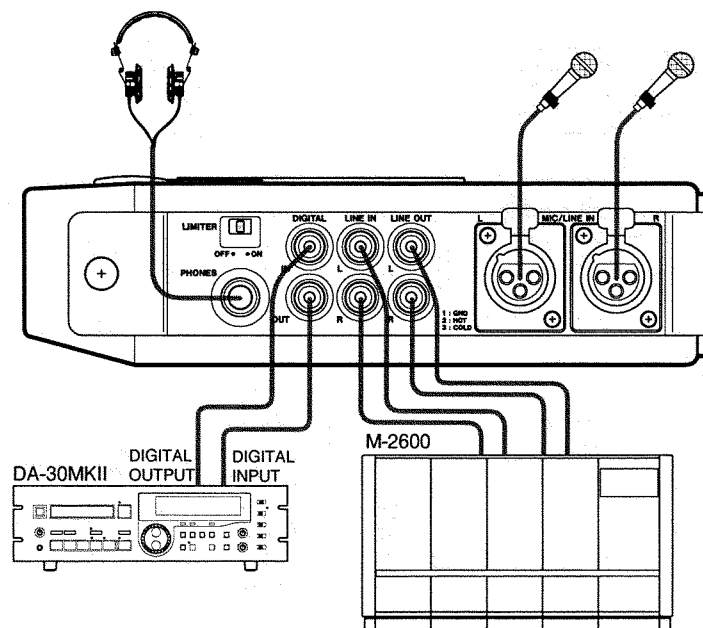

NOTE

Check to see that the write prohibit switch on the cassette you intend to record on is NOT open.

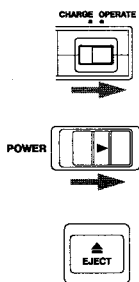

1. If you haven't done so yet, connect your recording source to the correct inputs of the deck and make all other necessary connections by referring to the diagram on page 6.
2. Locate the select switch on the left side of the deck and set it to OPERATE.
3. Turn the system on.
4. Press the **EJECT** button. The cassette holder will open.
5. Insert the cassette into the holder.
6. Depending on whether your recording source is analog or digital, proceed as follows:

Analog Source Recording

- (1) Make the following switch settings :

INPUT switch to ANALOG ;

ANALOG INPUT switch to MIC, PAD 20 dB or LINE depending on source (both the XLR and RCA inputs are active at the same time regardless of settings of the ANALOG INPUT switch) ;

PHANTOM switch to ON if phantom powered mics are in use (the phantom power remains switched off if the ANALOG INPUT switch is set to LINE) ;

Fs to 48 kHz for standard DAT recording or 44.1 kHz if the recording will be used as a digital CD master recording.

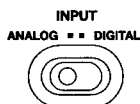

- (2) Press the **MARGIN RESET** button to see the instantaneous peak level of the current signal. The maximum level will read "0" in the MARGIN display, meaning that you have recorded to the maximum level allowable and there is no headroom left. If you exceed the maximum level, the "0" will blink.



- (3) Put the deck into "Input Monitor" mode by pressing **RECORD** (the transport must be in STOP when you press RECORD). Then, adjust the **INPUT L** and **R** level controls so that peaks from the source unit don't reach the OVER area in the peak level meters.

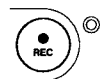

Set the **LIMITER** switch (on the right side panel) to ON if the source is a mic and is expected to have such dynamic range that you may want to decrease the input amplifier gain.

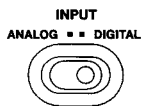

Digital Source Recording

Set the **INPUT** select switch to **DIGITAL**. The deck configures itself for the sampling rate of the incoming digital signal. The settings of the Fs switch are overridden. 48, 44.1, and 32 will light in turn and "DIGITAL IN" will flash in the LCD display if a suitable digital signal is not found.

Suggestion : If you intend to make a digital copy from a DAT recorder, you can copy subcode data (Start and Skip IDs) together with sound data by putting the deck into AUTO ID mode. Selecting this mode is explained on the next page.

- Recording digital sources does not require any input level adjustment.

7. If you are using a new blank tape :



Press **REW** (regardless of the current tape position). The tape will be located to a point 100 mm ahead of the end of the leader tape. If you don't perform this step, or record from the middle of a blank tape, ABS time will not be recorded in the subcode area for later reference, and the ABS display will be blank.

If you are using a tape containing some programs previously recorded :

Locate, if necessary, the **blank portion** of the tape by pressing **F FWD**. The tape will automatically stop either at the point beyond which there is nothing recorded so far or at an End ID mark if available. If the tape finds an End ID mark, "EE" shows in the left of the LCD display and "END" in the upper right. Otherwise "- E E -" shows in the center.

Avoid discontinuity in the ABS time by moving the tape back the length of 2 seconds or so. This allows the deck, when going into record mode, to read the ABS time from the previous recording and continue to record the ABS time without a break.

8. Hold down **RECORD** and press **PAUSE**.

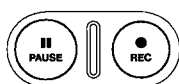

Automatic "Lead-in" Feature : If you are using a new blank tape, you will notice that $\overline{F} \overline{O} \overline{R} \overline{M} \overline{A} \overline{T}$ (format) shows in the LCD display window and the RECORD LED lights for about 10 seconds, during which a lead-in mark is automatically laid down on the tape. While Format is displayed, do not change settings of the INPUT or Fs select switches. Format goes out and the RECORD LED starts blinking when the lead-in mark is fully recorded and the transport enters normal record ready mode.

As a result of automatic lead-in recording, tape playback can begin at the lead-in mark rather than at the very beginning of the audio recording, so there is no risk of clipping first notes.

Directly entering record mode by holding RECORD and pressing PLAY (without passing through RECORD PAUSE mode) will also automatically record the lead-in mark before actually starting normal audio recording. But, be aware of the following :

Suggestion : While Format is displayed to show the lead-in mark is being recorded, no audio can be recorded. To follow a tight audio start, first record the lead-in mark in RECORD PAUSE instead of directly going into record mode.

Before performing step 9 (page 10), consider the following optional possibilities :

Start ID Marking Options

AUTO ID Mode

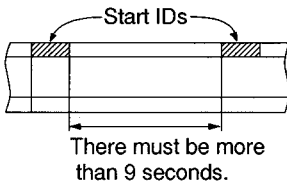
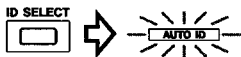

AUTO ID Level

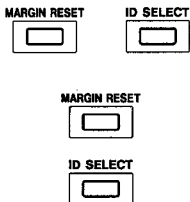

Manual Start ID Writing

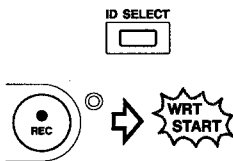

Start IDs are electronic index marks in the subcode area of the tape that make it easy to find the start of each selection on the tape. You can make Start ID marks during the initial audio recording, or add them to the recording later. Consider the following possibilities before actually initiating audio recording :

In this mode, Start ID and program number will automatically be recorded at each occurrence of audio level exceeding -48 dB or user selected decibels (discussed below) after a lapse of about 3 second lower levels or silence. (The first Start ID and program number after the deck is put into record mode are recorded when sounds exceeding a selected level are fed into the deck, regardless of the length of preceding lower signals or silence.) To put the deck into AUTO ID mode, press the **ID SELECT** switch to have "AUTO ID" light up in the display window.

Note that a quiet passage ("pianissimo") might cause the beginning of the next passage to be indexed and numbered as if it were a new program. Don't worry. You can correct it (with "Erase Start") later.

Restriction : No Start ID is automatically recorded unless there is more than 9 seconds since the previous Start ID.

The sensitivity of the AUTO ID circuit defaults to -48 dB but can be set to -42, -54, -60 or -66 dB. To change the sensitivity level :

- (1) When no ID editing mode is selected, hold down **MARGIN RESET** and press **ID SELECT**. The current sensitivity level will blink in the left of the display window.
- (2) Press **MARGIN RESET** until the desired level shows.
- (3) Press **ID SELECT** to make the setting effective.

☞ The setting is switched back to -48 dB when turning off the deck.

You can manually index the beginning of each program. Program time is automatically recorded together with Start IDs.

☞ There must be 9 seconds or more between two Start ID marks for the correct search function.

To enter Manual Start ID Writing mode :

Press **ID SELECT** until "WRT START" shows in the right of the LCD display.

A Start ID is laid down on tape when you hit **RECORD** after putting the deck into record. (You can also hit RECORD during play too.)

A Start ID recording lasts about 9 seconds and is noted by "WRT START" flashing in the right of the display.

☞ While a Start ID is being written, all transport buttons except for STOP are disabled.

Before starting audio recording, consider the possibility of recording Skip and End ID marks. See below for an explanation.



9. To start audio recording (analog or digital), press **PLAY** or **PAUSE**.

If you have selected "AUTO ID," the instant the first note of the music is actually fed to the tape, recording of the following starts at the same time :

- Start ID mark
- Program number (when the tape starts from its beginning or the previous PGM number is read)
- Program time

These three data items are recorded for 9 seconds each time a new audio recording is made.

Whether or not AUTO ID is selected, the point on the tape where the transport goes into record is automatically marked for later autolocation. It will be the same for the point where the transport exits record mode. Each time audio recording is made, the previous record-in and out marks are erased from memory and the new points are marked. Autolocating to those points is explained in the section on playback.

- To interrupt audio recording temporarily, press **PAUSE**. A subsequent pressing of **PLAY** or **PAUSE** will resume the recording.
- To definitely end recording, press **STOP**. You may want to end recording by marking the point with an End ID as explained below.

Recording Skip ID Marks

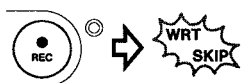

You can either enter Skip ID marks during the initial audio recording or they can be added to the recording during play.

If you want to enter a Skip ID while audio recording is taking place, proceed as follows:

- (1) Press the **ID SELECT** switch as many times as necessary to have "WRT SKIP" light in the LCD display.
- (2) At the desired moment during record, hit **RECORD**. "WRT SKIP" will blink for 1 second, during which a Skip ID mark is recorded on the tape.

Recording an End ID Mark

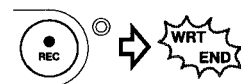

CAUTION

Don't write an End ID mark at an intermediate point of the existing audio recordings, which invalidates all the recordings that follow the End ID mark. For example, if your tape contains 10 programs and you re-record program #3 and terminate it by writing an End ID mark, then the tape will not run past that point and you cannot access programs #4-10 unless you erase that End ID mark by re-recording program #4.

- (1) Press the **ID SELECT** switch until "WRT END" lights in the LCD display.
- (2) When reaching the end of audio recording, hold down **RECORD** until "WRT END" blinks, indicating an End ID mark starts being recorded.

After 9 seconds, the indication will go out and the tape will automatically rewind, stopping at a point 2 seconds lower than the End ID mark recorded. This intentional overshoot ensures that the current End ID mark is fully erased, and that the deck continues to record ABS time without a break when you add a new audio recording to the end of the existing ones.

Playback

This deck is not capable of playing back recordings externally made at a 32 kHz sampling rate and in Long Play mode.

CAUTION

Avoid damaging your ears by turning the PHONES volume fully down before putting on the headphones.

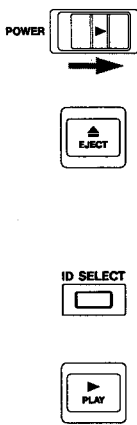

1. Check to see that all connections are correctly made.
2. Check to see that the **OPERATE/CHARGE** select switch is set to OPERATE on the left side panel.
3. Turn the system on.
4. Press **EJECT**. The cassette holder will open.
5. Insert the cassette in the holder. Notice that a cassette icon flashes in the LCD display to indicate that the tape is being loaded.
6. If you want the tape to skip to the next Start ID mark when it finds a Skip ID mark, press the **ID SELECT** switch to have "AUTO ID" light up on the display.
7. Press **PLAY** to have the tape start playing.
 - To interrupt play, press **PAUSE**. To resume play, press **PLAY** or **PAUSE**.
 - To definitely stop play, press **STOP**.

Autolocation

Autolocating to user marked points



Suggestion : Pressing PLAY during the autolocate process causes the tape automatically to start playing at the end of the autolocation. If you want the deck to go into Pause mode, you can press PAUSE instead of PLAY.

You can mark any point on the tape to which you want to autolocate, as follows :

Switch the time counter in the center of the LCD display to show ABS time with the **COUNTER MODE** switch, and when playback reaches the desired point, press the **RESET** button.

To autolocate to the mark, hold down **STOP** when the transport is in Stop and press **PLAY**. " L C " will appear in the left of the LCD display, the center time counter displaying the time address the tape is being located to.

☞ *The time counter shows a broken line if there is no mark stored in memory.*

☞ *Each time you mark a point on the tape, the previous one is erased.*

Autolocating to the record-in or out points

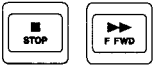
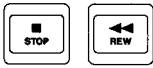

As stated earlier in the section on recording, the points on the tape where the deck went into, and out of record mode most recently has been stored in memory automatically.

To autolocate to the record-in point, hold down **STOP** and press **REW** when the transport is in Stop and the time counter is in its ABS mode. "17" will show in the left of the LCD display and the time counter will read out the time address the tape is being located to. Actually, the tape is located to the point plus a 2-second preroll time.

To autolocate to the record-out point, hold **STOP** and press **F FWD** when the transport is in Stop and the time counter is in its ABS mode. "05" will show in the left of the LCD display and the time counter will show the time address the tape is being located to. Actually, the tape is located to the point plus a 2-second preroll time.

☞ As with the user marked autolocation point, if there is no record-in or out marks in memory, the time counter shows a broken line.

Choosing Selections

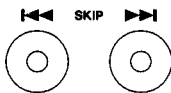

To advance to the next selection, press the forward **SKIP** button. The tape will fast-forward to the next Start ID mark and stop. If **PLAY** is pressed before or after **SKIP**, the tape automatically plays from that point on. You may press the forward or reverse **SKIP** button a number of times to skip over several selections.

If you want the deck to go into pause at the end of skip functions, press **PAUSE** before or after **SKIP**.

Editing Start and Skip ID Marks

IMPORTANT

- When Start IDs are added or erased, program numbers on tape get out of order. Be sure to restore program numbers to proper sequence by going through the RENUMBER operation (discussed below).
- No Skip ID can be recorded where a Start ID mark exists.

Recording Start/Skip ID Marks



You can enter Start and Skip ID marks only when the tape is playing.

1. Press the **ID SELECT** switch until "WRT START" or "WRT SKIP" lights in the LCD display.
2. Play the tape to locate to the point where you want to enter a Start or Skip ID mark, and press **RECORD**.

Erasing Start/Skip ID Marks



Renumbering



"WRT START" or "WRT SKIP" will flash to indicate that the corresponding mark is being recorded. The Start ID mark is recorded for 9 seconds, and the Skip ID mark is recorded for 1 second. Entering a Start ID requires that the current location is more than 9 seconds (in terms of ABS time) apart from the previous Start ID mark (if available).

☞ While a Start or Skip ID mark is being recorded, all the transport controls are disabled except for STOP.

You can erase Start or Skip ID marks when the transport is in STOP, PLAY or PLAY PAUSE.

○ Erasing Start or Skip ID marks does not affect any audio data recorded on tape.

1. Press the **ID SELECT** switch until "ERASE START " or "ERASE SKIP" lights in the LCD display.
2. Press **RECORD**. The tape will rewind back to the beginning of the previous Start or Skip ID mark, and will automatically start running at normal play speed (program material muted) to erase the mark encountered, as confirmed by "ERASE START" or "ERASE SKIP" flashing.

When erasing is complete, program material is unmuted. The tape continues to run at normal play speed.

When adding or erasing Start ID marks, the program numbers on tape get out of order. All programs then need to be "renumbered" in order, as follows :

1. When the transport is in PLAY, PLAY PAUSE or STOP, press the **ID SELECT** switch until "RENUM" lights in the LCD display.

- 2 Press **RECORD**.

The tape will rewind to its beginning, and the renumbering process will start, as confirmed by the RENUM indicator flashing.

Features and Controls

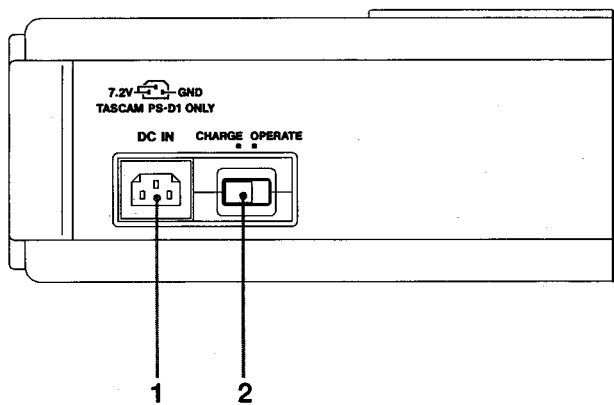
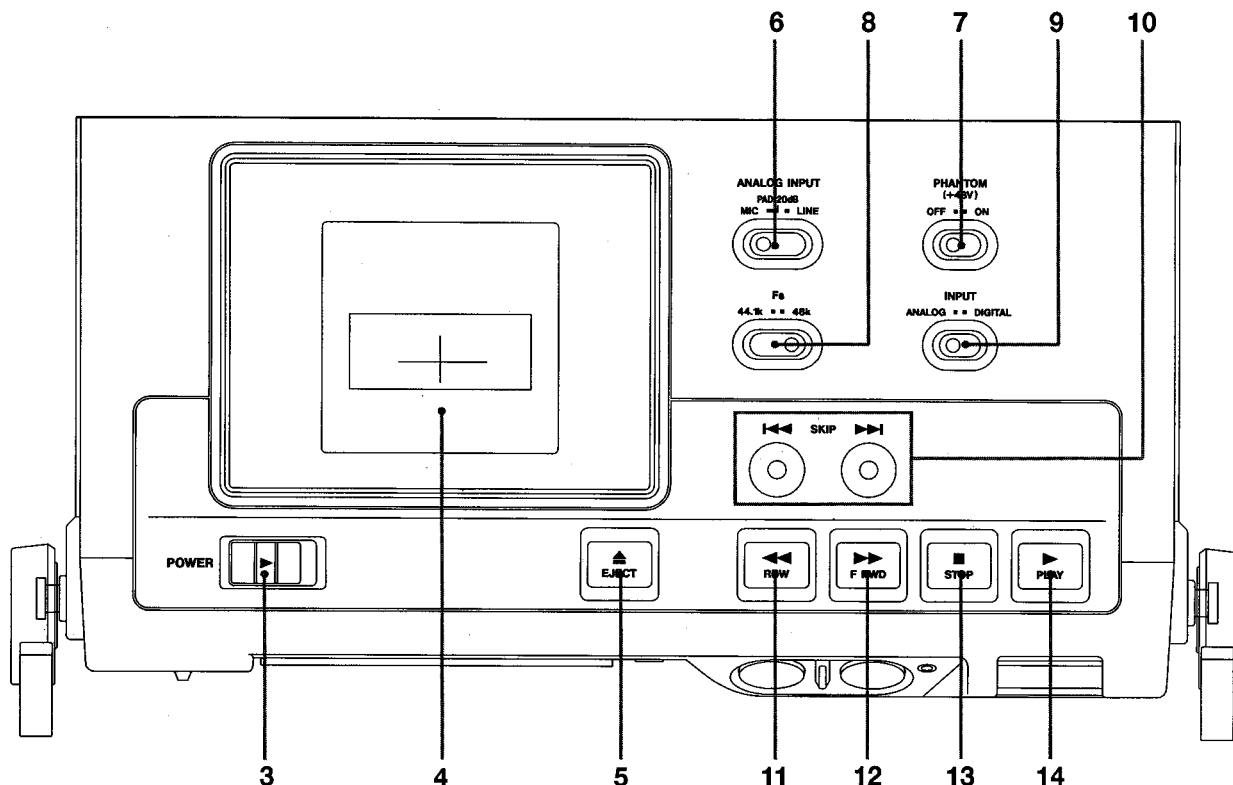

Left Side Panel

1. DC IN connector

For connection to the provided PS-D1 adaptor only.

2. OPERATE/CHARGE select switch

Set to OPERATE for the deck to be operated (using AC current or battery), or CHARGE for charging the battery.

NOTE

If this switch is NOT set to OPERATE, all other switches and buttons cannot operate.

Top Panel

3. POWER switch

Slide to the right to switch on power to the deck.

If you do so while holding down STOP (when the deck is battery powered), the Auto Power Off feature (p.6) is defeated.

4. Cassette holder

For loading DAT cassettes only. Conventional audio cassettes are not accepted.

5. EJECT button

Press to open the cassette holder. Effective only when the CHARGE/OPERATE switch is set to OPERATE and the transport is in STOP or the deck is turned off.

When pressing EJECT, the tape counter (shown or hidden) is reset to 0000 and the MARGIN reading is cleared.

6. ANALOG INPUT switch

When using inputs to the MIC/LINE IN XLR connectors, set to MIC if the source is a mic or PAD 20 dB to attenuate the mic inputs, or set to LINE for recording from line level sources.

7. PHANTOM (+48V) switch

Set to ON when using phantom powered mics. When setting the ANALOG INPUT switch to LINE, the phantom power is automatically switched off.

WARNINGS

The PHANTOM switch must be OFF when no phantom powered mics are used.

Don't operate the PHANTOM switch when recording is taking place or while in Input Monitor mode.

"MICROPHONE CABLES AND MICROPHONES CONNECTION: TO PREVENT HAZARD OR DAMAGE, ENSURE THAT ONLY MICROPHONE CABLES AND MICROPHONES DESIGNED TO THE IEC 268-15A STANDARD ARE CONNECTED."

"CONNEXIONS DES MICROPHONES ET DE LEURS CABLES: POUR EVITER TOUT ENDOMMAGEMENT, S'ASSURER DE BRANCHER UNIQUEMENT DES MICROPHONES ET DES CABLES DE MICROPHONES CONÇUS SELON LA NORME IEC 268-15A."

8. Fs select switch

This selects the sampling rate that will be used for recording analog inputs only.

Set to 44.1 kHz if the tape will be used as a digital master for CD production, or 48 kHz if the tape will be used for other applications.

This switch has no effect when recording from digital inputs or during playback. In these cases, the deck will automatically switch to the frequency at which those sources were originally recorded, as indicated by 48, 44.1 or 32 in the upper right corner of the display window.

9. INPUT select switch

Set to ANALOG when recording from the analog XLR balanced inputs or RCA unbalanced inputs, or DIGITAL when recording from DIGITAL IN.

"48," "44.1," and "32" will light in turn in the upper right corner of the display window and "DIGITAL IN" will flash in the center if, when recording from digital sources, a suitable digital signal is not found.

10. SKIP buttons

Effective in PLAY, PAUSE, and STOP. When pressed once, the left button rewinds the tape to the beginning of the current program. Press the button repeatedly to skip over several programs. The right button fast-forwards the tape to the beginning of the next program.

The deck automatically starts playing or goes into pause mode at the end of search functions if you press PLAY or PAUSE before or after SKIP.

After skip has started, you can change the number of programs to skip over. For example, if you press the right SKIP button, say 5 times running, and then the left SKIP button once, you'll skip to the fourth program ahead, instead of the fifth.

11. REW button

If pressed when in STOP or running in F FWD, winds the tape at high speed in reverse.

If pressed once during play, offers 3 times normal speed reverse cueing for review. If pressed twice, offers 9 times normal speed reverse cueing. A third press, switches back to 3 times normal speed reverse cueing.

Holding down the button (for 1 second or more) during play also allows cueing to an earlier point. Review starts from the point where you release the button.

A tap on REW during forward cueing (activated with F FWD in a similar way to activating reverse cueing) switches to the same speed reverse cueing ; inversely, a tap on F FWD during reverse cueing switches to the same speed forward cueing.

Another function is to autolocate the tape to a record-in point. See the section on playback for an explanation.

12. F FWD button

Similar to REW, but winds the tape in the forward direction, offers the forward cueing, or autolocates to a record-out point.

It is also used to autolocate the tape either to the point beyond which there is nothing recorded so far or to an End ID marked point. The tape will move back over the length of 2 seconds when it finds an End ID mark.

13. STOP button

Stops any tape motion. It also stops the DAT head drum from spinning against the tape.

It is also used to disable Input Monitor mode.

14. PLAY button

If pressed while in STOP, REW or F FWD, starts tape playback.

If pressed after PAUSE, resumes playback from the point of interruption.

If pressed while in record ready (RECORD PAUSE), starts recording.

If pressed before or after SKIP, starts playback at the end of search functions.

It is also used to have the tape automatically start playing after completing autolocation.

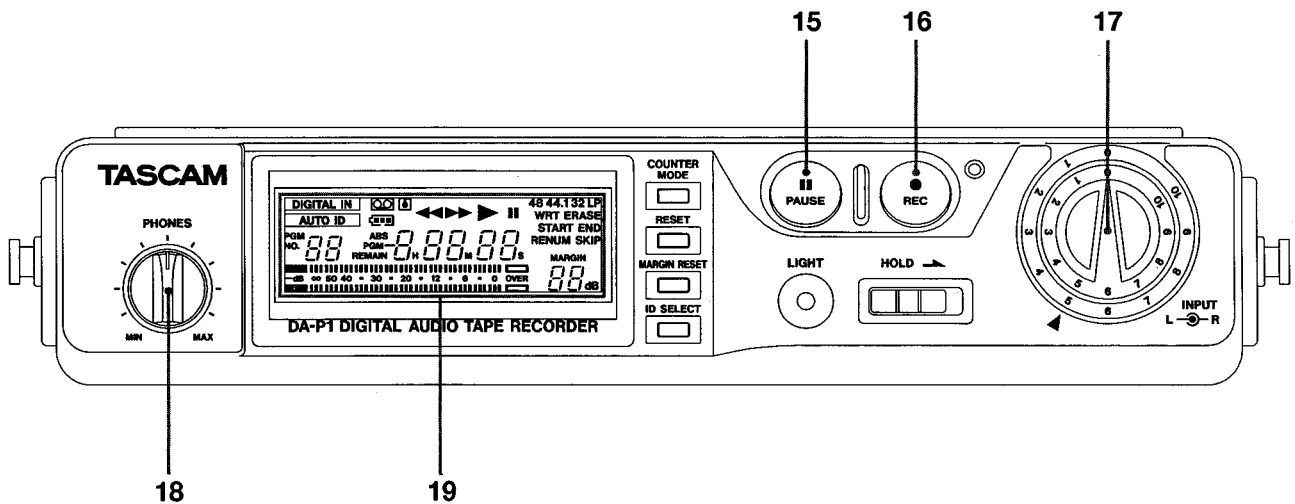

Front Panel

15. PAUSE button

If pressed during record or play, temporarily stops the tape. Pressing PAUSE or PLAY resumes record or play accordingly.

If pressed while in STOP, activates Play Ready mode ; then press PAUSE or PLAY to start playback.

If pressed while holding down RECORD, activates Record Ready mode ; then press PAUSE or PLAY to start recording.

If pressed before or after SKIP, puts the deck into pause mode at the end of search functions.

It is also used to have the deck go into pause mode after completing autolocation.

NOTES

- If you interrupt Record by pressing PAUSE and leave the deck in that status, the deck will automatically go into "Input Monitor" mode after 5 minutes.
- If you interrupt Play by pressing PAUSE and leave the deck in that status, then the deck will go into STOP after 5 minutes.

16. RECORD button

Pressing PLAY while holding down RECORD starts recording. You may first want to go into Record Ready mode by pressing PAUSE while holding down RECORD.

The associated LED blinks during Record Ready mode. It glows solid and the ► indicator lights in the LCD display window when recording starts. The LED also lights when "Input Monitor" mode is entered by pressing RECORD when the transport is in STOP.

Difference between the Record Ready and the Input Monitor Mode : Record Ready is a mode accessible by holding RECORD and pressing PAUSE. The head drum is in motion in this mode. After 5 minutes, the mode is automatically cancelled.

Input Monitor mode is entered by pressing RECORD in STOP. The drum is not in motion. To leave the Input Monitor mode, press STOP. The Input Monitor mode can be entered even when no cassette is inserted into the deck. In this case, the RECORD LED does not light. Depending on whether the input signal is analog or digital, "A-d-A" or "d-A" will show in the display.

The proper recording levels can be set in either Record Ready or Input Monitor modes.

NOTE

The Input Monitor mode cannot be entered if the tape is write protected.

17. INPUT level controls

The center knob adjusts the recording level of the left input, and the outer ring adjusts the recording level of the right input. Valid only for the record level of analog inputs.

When you turn the outer control, the inner control also turns. To turn the outer control only, hold the inner control.

18. PHONES control

Adjusts the listening level of the headphones plugged into the PHONES jack on the right side panel.

CAUTION

Avoid damaging your ears by fully turning down the PHONES control before putting on the headphones. To hear sounds, turn the control up slowly.

19. LCD (Liquid Crystal Display)

This backlit display (see also #24) provides you with a variety of information, keeping you aware of what is currently taking place.

DIGITAL IN : Lights when the INPUT select switch is set to DIGITAL. Blinks when suitable digital signals are not fed into the deck.

AUTO ID : Lights when AUTO ID mode (p.9) is selected. This mode is also used to have the tape skip to the next Start ID mark when a Skip ID mark is encountered during play.

 : Blinks when a tape is being loaded. Glows solid when loading is complete. It does not appear when there is no tape inside the deck.

 : Blinks when condensation occurs in the deck.

 : This is a battery meter with its 3 segments representing a scale. As the battery power goes low, the segments turn off in sequence, and then the last, right segment starts blinking to warn you that the battery would fully run down in about 10 minutes of continuous record.

CAUTION

To maximize the service life of the battery, avoid recharging the battery before the battery warning starts blinking.

 : Rewind, fast forward, play, and pause are indicated by the corresponding marks being lit.

PGM NO : Shows the current program number. Also displayed is the current sensitivity level of the AUTO ID circuit when selecting "AUTO ID" with the ID SELECT switch.

ABS : Indicates the elapsed time from the beginning of the tape up to the current position. If a broken line shows in the ABS display mode, the tape was not recorded with ABS time data.

PGM : Indicates the elapsed time from the start of the program currently being played back. The deck will calculate elapsed time since the previous Start ID. A broken line will show if the tape is inserted in-between Start IDs.

REMAIN : Indicates the remaining time on the tape. When a prerecorded music tape (encoded with "TOC") is being played back, the reading is to second accuracy. If the tape is not recorded with TOC, the seconds column will be blank.

A broken line is displayed when the deck is calculating the remaining time on the tape.

Tape Counter (when neither ABS nor PGM nor REMAIN shows, as selected with the COUNTER MODE switch) : Indicates the distance the tape has travelled from a zero reference point established with the RESET button.

Peak Level Meters : These register input levels during Record Ready, Input Monitor (see #16) or Record modes and, output levels during Play.

48, 44.1, 32, and 32LP : In analog recording, 48 or 44.1 will light, as selected by the Fs switch. In digital recording, 48, 44.1, or 32 will light depending on incoming signals. 48, 44.1 and 32 will light in turn and DIGITAL IN will blink if suitable digital signals are not fed into the deck.

32LP will blink to indicate that the tape cannot be played back with this deck because it is originally recorded at the sampling rate of 32 kHz and in Long Play mode.

(ID Mode indications) : This section of the display shows the current ID editing mode, as selected by the ID SELECT switch. A blinking indicator shows the corresponding ID mark is being written on tape or erased or programs are being renumbered. Each time an ID mark is read off tape, the corresponding indicator lights steadily.

MARGIN : This is a digital peak-hold meter, showing the available headroom before digital saturation is reached and distortion occurs. It holds the highest reading since MARGIN RESET was last pressed (the reading is also reset when EJECT is pressed). It ranges between 39 and 0 dB during recording. If 0 dB is flashing, it indicates that the meter reached the OVERload point. The OVER indication cannot appear while in playback.

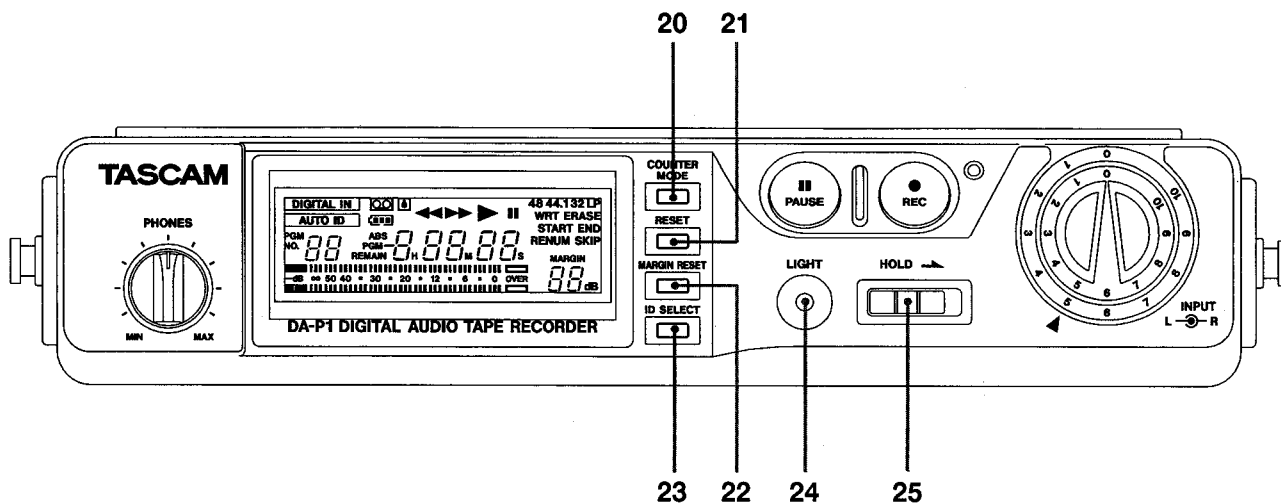

20. COUNTER MODE switch

Each time this switch is pressed, the following information shows in sequence in the center of the display window.

1. ABS (absolute) time : elapsed time from the beginning of the tape
2. PGM (program) time : elapsed time from the beginning of each program
3. REMAIN time : remaining time on the tape
4. Distance the tape has travelled from a zero reference point
5. TOC (if available) : total number of programs on the tape and total play time

To select the TOC mode, you have to let the tape play for several seconds in advance after inserting it into the deck.

After a 3-second TOC reading, the display will automatically be switched back to show the ABS time.

21. RESET button

Establishes a new zero reference point. This button has effect only when the display is switched to Tape Counter mode, as selected with the COUNTER MODE switch.

EJECT also clears the tape counter to 0000 (shown or hidden).

Another function is to mark a point to which you want to autolocate, as discussed in the section on playback.

22. MARGIN RESET button

Defeats a MARGIN (headroom available) indication so new readings can be taken.

23. ID SELECT switch

Each time this switch is pressed the following ID editing modes are selected in sequence, as indicated by the display. The modes that can be entered differ depending on the current transport modes as shown :

RECORD or RECORD PAUSE	Blank (ID mode off)
	AUTO ID
	WRT START
	WRT SKIP
	WRT END

Other modes	Blank (ID mode off)
	AUTO ID
	WRT START
	WRT SKIP
	ERASE START
	ERASE SKIP
	RENUM

After the display indicates the desired ID editing mode, pressing the RECORD button will actually execute the ID mode selected. See also the section on editing ID marks.

NOTE

The ID SELECT switch cannot operate if the cassette is write protected.

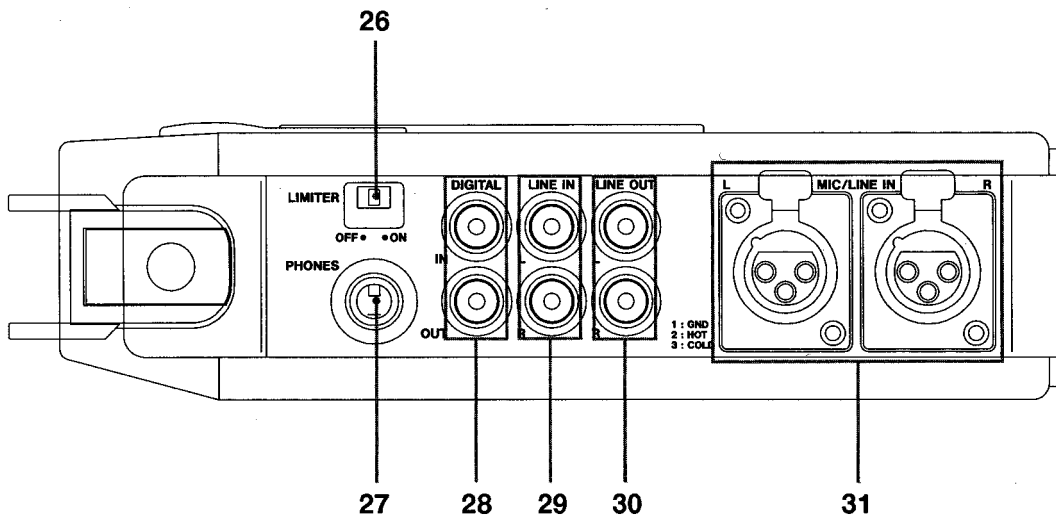

Right Side Panel

24. LIGHT switch

Used when the deck is battery powered. Press to back light the LCD display. The light will automatically turn off at the end of 10 seconds. When the display is backlit, if you press LIGHT once more, the display will be turned off.

The display is automatically backlit when the deck is powered from the AC outlet. You can turn off the light by pressing LIGHT.

25. HOLD switch

If slid to the right, locks all the push buttons (except for COUNTER MODE, RESET, and MARGIN RESET) to their current positions and prevents them from being accidentally operated. If you attempt to operate a button and it is disabled, "HOLD" appears in the LCD display window to remind you that you must first slide the switch back to the left.

26. LIMITER switch

Set to ON so a built-in limiter prevents the signal level from exceeding 0 dB when recording from mics (with ANALOG INPUT set to MIC or PAD).

27. PHONES jack

For connection to stereo headphones only. Don't use 2 conductor mono headphones with this jack.

28. DIGITAL IN and OUT connectors

These RCA IN/OUT jacks are for connection to the S/PDIF (IEC 958 TYPE II) digital I/O ports of external digital equipment through a 75 ohm coaxial cable.

29. LINE IN connectors

These RCA jacks are for plugging unbalanced analog sources into the deck.

When these connectors are in use, be sure to set the ANALOG INPUT switch to its LINE position for optimum S/N performance.

30. LINE OUT connectors

For connection to the unbalanced analog signal inputs of external equipment.

31. MIC/LINE IN connectors

These balanced XLR type connectors accept balanced analog sources. Pin 1 is GND, Pin 2 is HOT, and Pin 3 is COLD.

Specifications

Format : Rotary head digital audio tape deck
Record Time : 120 minutes (with 120-min tape)
Fast Winding Time : Approx. 60 seconds
Tape Speed : 8.15 mm/sec. (12.225 mm/sec. during play)
Quantization : 16-bit linear
Error Correction Method : Octuple error correction
Drum Speed : 2,000 rpm
Sampling Rates :
 48 kHz recording (digital/analog), play
 44.1 kHz recording (digital/analog), play
 32 kHz recording (digital only), play
Channel : 2 channels
Frequency Response : 20 Hz to 20 kHz, ± 0.5 dB (44.1/48 kHz) (LINE)
S/N : Better than 90 dB (LINE)
Dynamic Range : Better than 90 dB (LINE)
Total Harmonic Distortion : Better than 0.007%, 1 kHz (LINE)
Channel Separation : Better than 85 dB (1 kHz)
Wow and Flutter : Unmeasurable (less than $\pm 0.001\%$)
Analog I/O
MIC/LINE IN (XLR-3-31 x 2)
MIC
 Nominal level : -60 dBm (0.8 mV)
 PAD : 20 dB
 Input impedance : 2.5 kohms, balanced
LINE
 Nominal level : +4 dBm (1.2 V)
 Input impedance : 10 kohms, balanced
LINE IN (RCA x 2)
 Nominal level : -10 dBv (0.3 V)
 Input impedance : 35 kohms, unbalanced

LINE OUT (RCA x2) :
 Nominal level : -10 dBv (0.3 V)(10-kohm load)
 Output impedance : 500 ohms, unbalanced
PHONES (1/4" jack x 1)
 Max. output level : 15 mW + 15 mW (32 ohms)
Digital I/O
IN (RCA x 1) : IEC 958 TYPE II (S/PDIF)
OUT (RCA x 1) : IEC 958 TYPE II (S/PDIF)
Power Supply : 2-way (AC adaptor PS-D1 and Ni-Cd battery BP-D1 (7.2 V, 1.4 Ah))
U.S.A./Canada : 120 VAC, 60 Hz
Europe : 230 VAC, 50 Hz
U.K./Australia : 240 VAC, 50 Hz
Power Consumption :
 13W (with PS-D1, during OPERATE)
 15W (with PS-D1, during CHARGE)
Battery Charging Time : Within approx. 2.5 hours
Battery Life : Approx. 120 minutes (continuous recording, PHANTOM OFF), approx. 100 minutes (continuous recording, PHANTOM ON, (2 mA x 2)), Approx. 180 minutes (stop)
Dimensions (WxHxD) : 258 x 54 x 188 mm (10-3/16" x 2-1/8" x 7-3/8")
Weight : 1.2 kg (2-10/16 lbs) (excluding battery (240 g))
Supplied Accessories : AC adaptor/battery charger (PS-D1), Ni-Cd battery (BP-D1), and Carrying belt

- In these specifications, 0 dBv is referenced to 1 Volt, and 0 dBm is referenced to 0.775 Vrms. Actual voltage levels are also given in parenthesis (0.316 V for -10 dBv rounded off to 0.3 V).
- Changes in specifications and features may be made without notice or obligation.

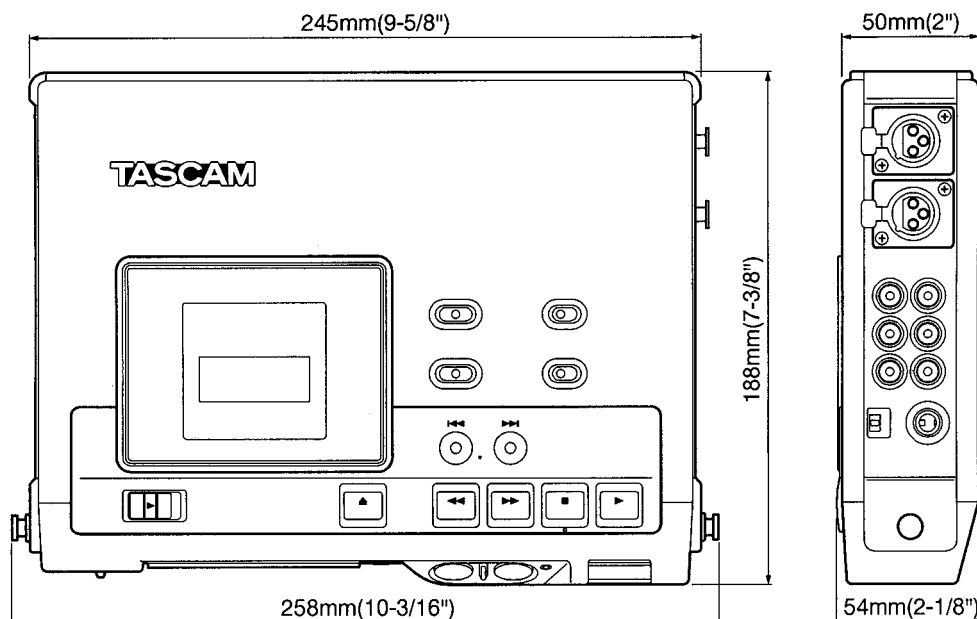

DA-P1 External Dimensions



Problems and Solutions

Problem	Probable Causes	Solution
No power	1. AC adaptor unplugged. 2. Battery not charged. 3. CHARGE/OPERATE switch set to CHARGE.	1. Plug in AC adaptor. 2. Recharge battery. 3. Set switch to OPERATE.
Controls not operable	1. HOLD switch engaged. 2. Condensation.	1. Disengage switch. 2. Wait for 1 or 2 hours.
ID SELECT switch not operable	Write protect switch open.	Close write protect switch.
Recording impossible	Write protect switch open.	Close write protect switch.
Mics not operable	1. Incorrect ANALOG INPUT selector setting. 2. Phantom mics in use, but PHANTOM switch not engaged.	1. Correct setting. 2. Engage switch.
Start ID marking not automated during audio record	1. AUTO ID mode not selected. 2. Improper sensitivity level setting.	1. Press ID SELECT to have AUTO ID light up. 2. Correct setting (p.9)
Cannot record ABS time	Audio record started from an intermediate point.	Before starting audio record, rewind the tape to the beginning or a point where ABS time is previously recorded.
Cannot monitor digital inputs	Incorrect connection of digital sources.	Correct connection.
Battery warning blinks although the battery has been fully charged shortly before. Shortly after the battery starts charging, the red LED on the adaptor/charger turns green.	1. Memory effect. 2. Service life of the battery ended.	1. Fully discharge the battery by leaving the deck in STOP before recharging. 2. Replace with a new battery pack.
LED on the adaptor/charger doesn't light after starting charging battery.	1. Incorrect insertion of the battery pack. 2. Overdischarged.	1. Insert the battery pack correctly. 2. Continue to charge. LED will light red after a while.
Cannot enter Input Monitor mode.	An ID editing mode is selected.	Disable the mode with ID SELECT.
Deck under battery power automatically turned off.	1. Battery has run down. 2. Deck left in STOP for 6 minutes.	1. Recharge battery. 2. Switch on power again (p.6).
Tape cannot stop immediately after pressing STOP.	ID mark-related functions (write, erase, etc) in progress.	Wait for a while.
No playback sounds	1. Heads are dirty. 2. Programs recorded at 32 kHz in Long Play mode.	1. Clean heads with commercially available head cleaning tape. 2. This deck is not capable of playing these programs.

Error Messages

Display	Problem	Solution
"  " blinking	Condensation	Wait for 1 hour or 2 before using the deck.
"  " blinking	Battery needs charging.	Charge battery. (About 10 minutes of continuous record can be made after the warning starts blinking).
"DIGITAL IN" blinking	Suitable digital signals are not found.	Check connection.
"Hold"	You attempted to operate disabled buttons.	Slide HOLD switch to the left to release the function.

Block Diagram

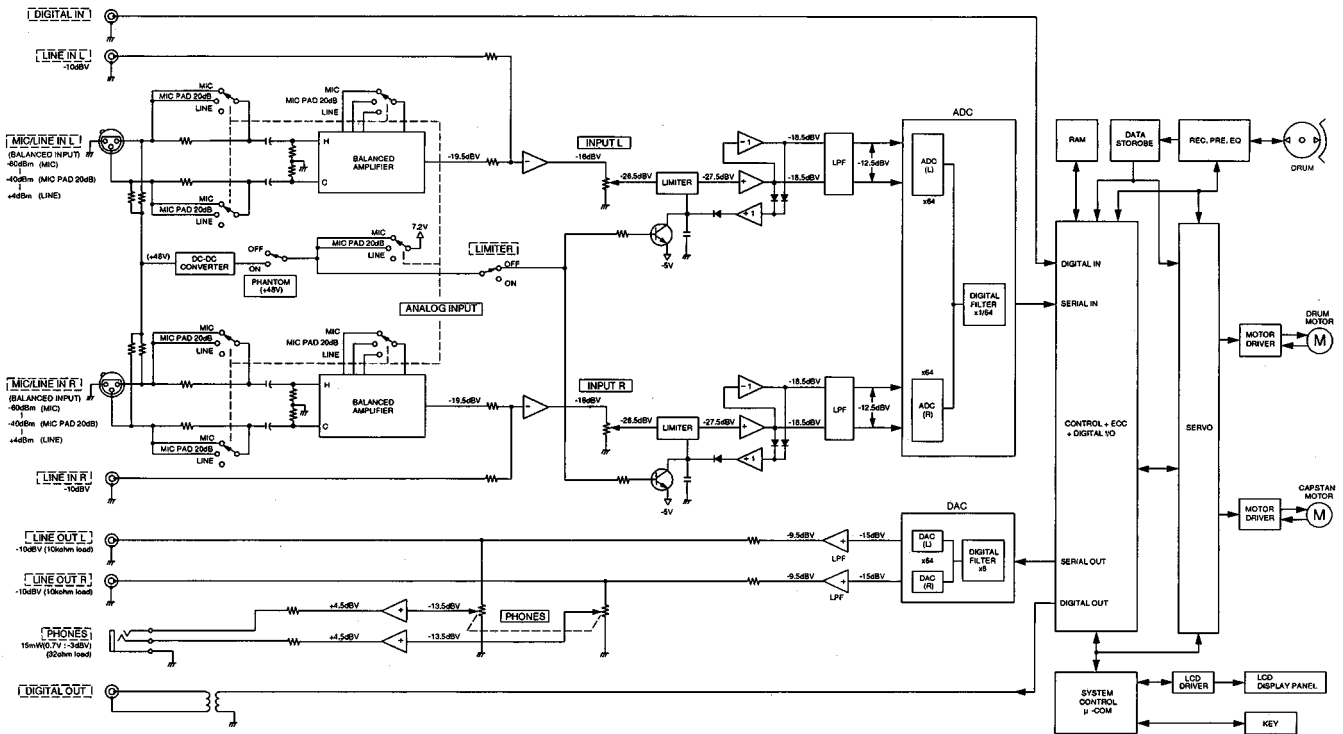

For U.S.A.

TO THE USER

This equipment has been tested and found to comply with the limits for a Class A digital device, pursuant to Part 15 of the FCC Rules. These limits are designed to provide reasonable protection against harmful interference when the equipment is operated in a commercial environment. This equipment generates, uses, and can radiate radio frequency energy and, if not installed and used in accordance with the instruction manual, may cause harmful interference to radio communications.

Operation of this equipment in a residential area is likely to cause harmful interference in which case the user will be required to correct the interference at his own expense.

CAUTION:

Changes or modifications to this equipment not expressly approved by TEAC CORPORATION for compliance could void the user's authority to operate this equipment.

Optional Accessories

CS-D1 Carrying Case

CB-D1 Battery Charge Box

BP-D1 Ni-Cd Rechargeable Battery Pack

TASCAM

TEAC Professional Division

DA-P1

TEAC CORPORATION	3-7-3, Nakacho, Musashino-shi, Tokyo 180, Japan Phone: (0422) 52-5081
TEAC AMERICA, INC.	7733 Telegraph Road, Montebello, California 90640 Phone: (213) 726-0303
TEAC CANADA LTD.	340 Brunel Road, Mississauga, Ontario L4Z 2C2, Canada Phone: 905-890-8008
TEAC UK LIMITED	5 Marlin House, Marlin Meadow, The Croxley Centre, Watford, Herts. WD1 8YA, U.K. Phone: 01923-819699
TEAC DEUTSCHLAND GmbH	Bahnstrasse 12, 65205 Wiesbaden-Erbenheim, Germany Phone: 0611-71580
TEAC FRANCE S.A.	17, Rue Alexis-de-Tocqueville, CE 005 92182 Antony Cedex, France Phone: (1) 42.37.01.02
TEAC NEDERLAND BV	Perkinsbaan 11, 3439 ND Nieuwegein, Nederland Phone: 03-402-30229
TEAC AUSTRALIA PTY., LTD. A.C.N. 005 408 462	106 Bay Street, Port Melbourne, Victoria 3207, Australia Phone: (03) 646-1733
TEAC ITALIANA S.p.A.	Via C. Cantù 5, 20092 Cinisello Balsamo, Milano, Italy Phone: 02-66010500
